

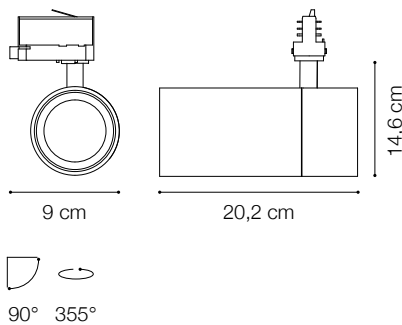

TRACKLIGHTS

Extruded aluminum cylindrical tracklight suitable for installation on three-phase track. White or black powder coating, 355° turning head and 90° adjustable, the power driver is included and located in the cylindrical body of the projector itself. Dimmable 1-10 or DALI version available. Light source with integrated COB LED technology for maximum efficiency, available with a color temperature of 3000K or 4000K; Energy efficient LED with high color rendering, up to CRI ≥ 90; starting binning ≤3-Step MacAdam; symmetrical beam optic with three different emission angles and glare control (UGR <19); assembly and disassembly without tools; IP20 protection; insulation class I. Ideal for installation in big rooms, where great flexibility and color rendering is required, such as MUSEUM, COMMERCIAL and RETAIL spaces.

Code	222646
Item name	QUICK 28W CRI80 30° 4000K BK ON-OFF
Source	LED COB CITIZEN
Power	28W
Driver included	TRIDONIC ON-OFF
Driver available	No
Lumen	4100 Lm
MacAdam	SDCM 3
Beam	30°
CCT	4000K
CRI	≥80
UGR	-
LED Life	50.000 h
Insulation class	Class I
IP	20
Material	Aluminum
Warranty	5 years
Net Weight	1,120 Kg
Volume	0,0061 m³



Code 222714
Item name QUICK 28W HONEYCOMB

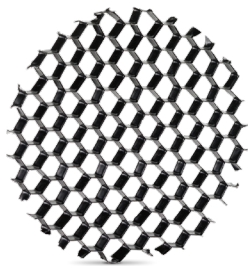

Code 222691
Item name QUICK 28W LENS 18°
Code 222707
Item name QUICK 28W LENS 45°



Code 170152
Item name LINK SINGLE CONNECTION BK ON-OFF

