

# ideal lux | Fluo Bi-emission

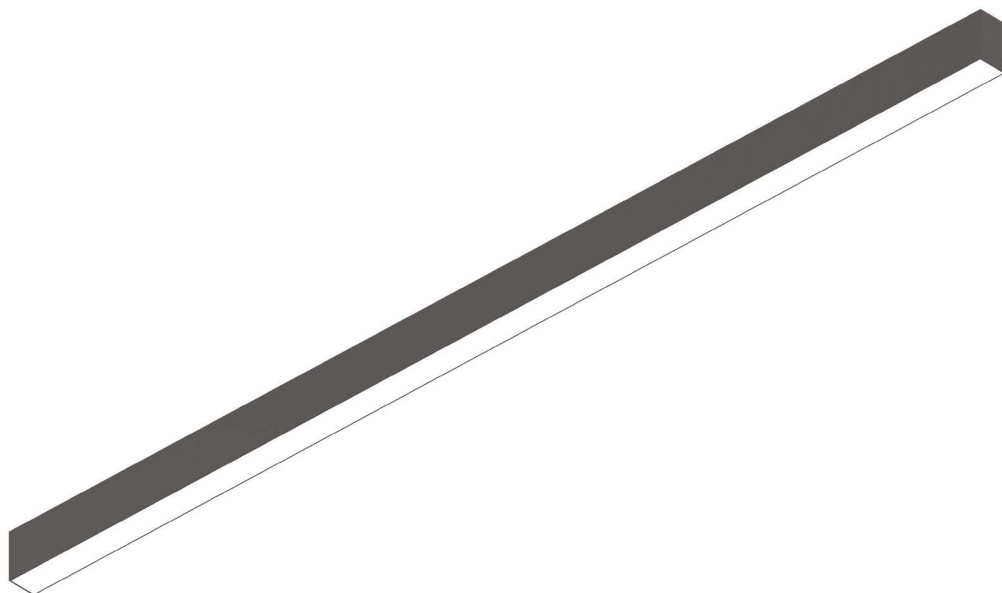

## LINEAR SYSTEM

Linear system of lamps with extruded aluminum body with a 50 mm wide and 80 mm high section, modules available in two lengths: 1200 mm and 1800 mm, which can be assembled according to the desired arrangement, possibility of assembling three different source modules: the WIDE diffusing module, the BIEMISSION module with light component for indirect lighting and the ACCENT module with UGR control lower than 19, integrated LEDs, color temperature options of 3000K or 4000K, starting binning  $\leq 3$  -Step MacAdam, minimum 80% of luminous flux remaining after 30000 h duration, IP20 protection, insulation class I.

The system is available in anodized aluminum, white and black colors and it is possible to install it in different ways: ceiling-mounted or flush-mounted in plasterboard ceilings. Driver included, integrated in the lighting fitting, available in both DALI and 1-10V dimmable versions. System suitable for locations where professional lighting with minimal design is required, such as OFFICES and SHOPS.



Suggestion



Suggestion

Code	192697
Item name	FLUO BI-EMISSION 1800 3000K BLACK
Source	LED SMD SAMSUNG
Power	36W   18W
Driver included	TRIDONIC
Driver available	1-10V   DALI
Lumen	3800 Lumen   2600 Lumen
MacAdam	3SDC
Beam	105°   105°
CCT	3000K
CRI	$\geq 83$
UGR	<27
LED Life	30.000 h
Insulation class	Class I
IP	20
Material	Aluminum
Warranty	5 years
Net Weight	4,420 Kg
Volume	0,0360 m <sup>3</sup>
Dimmable	On request
Customizable	Yes

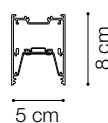
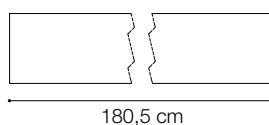

# ideal lux | Fluo Bi-emission

**MOUNTING KIT  
NOT INCLUDED | REQUIRED**

Code 191164  
Item name FLUO KIT PENDANT BK  
Length 170 cm



# ideal lux | Fluo Bi-emission

NOT INCLUDED | OPTIONAL



Code 191508  
Item name FLUO PROFILE CONNECTOR

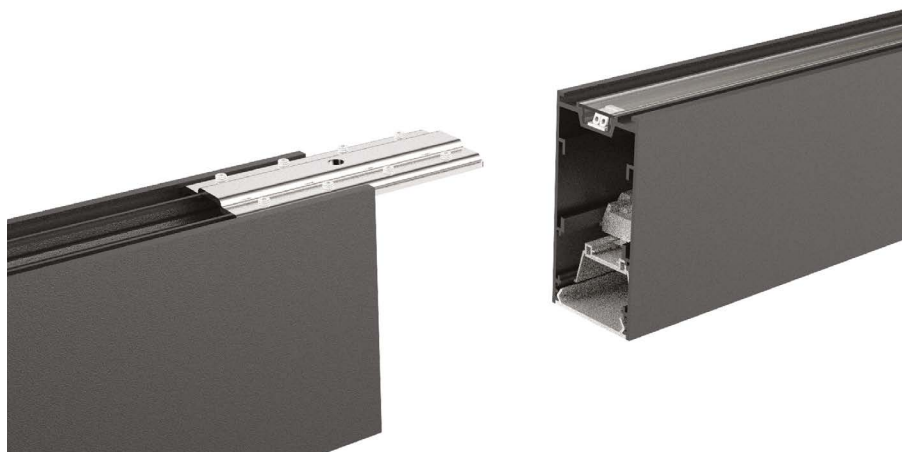

Code 191492  
Item name FLUO CORNER BLINDED BK  
Material Aluminum  
Warranty 5 years  
Net Weight 0,610 Kg  
Volume 0,0023 m<sup>3</sup>

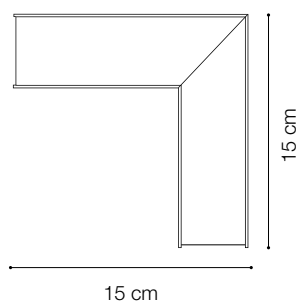
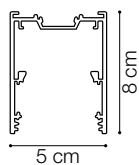

# ideal lux | Fluo Bi-emission

**DRIVER**  
**NOT INCLUDED | OPTIONAL**

Code	216430
Item name	FLUO DRIVER 1-10V 350mA
Power	20W
Output	27/56 Vdc
Current	350 mA
Measure	280 x 30 x 21 mm

Code	216294
Item name	FLUO DRIVER DALI 350mA
Power	19W
Output	20/54 Vdc
Current	350 mA
Measure	280 x 30 x 21 mm