



TRACKLIGHTS

Cylindrical aluminum projector (extrusion + CNC manufacturing + forging) suitable for installation on three-phase track. White or black powder coating, 350 ° rotating head and 90 ° adjustable, the power driver is included and is located in the cylindrical body of the projector itself; light source with integrated LED COB technology, available with a color temperature of 3000K or 4000K and with color rendering index up to 90; starting binning ≤ 4-Step MacAdam; min. 80% of luminous flux remaining after 50000 h duration; symmetrical beam optic with three different emission angles and glare control (UGR <19); assembly and disassembly without tools; IP 20 protection; insulation class II. Ideal for the installation in big rooms, where great flexibility and color rendering is required, such as MUSEUM, COMMERCIAL and RETAIL



Code	189574
Item name	SMILE 15W CRI80 24° 3000K WH
Source	LED COB PHILIPS
Power	15W
Driver included	RX-POWER
Driver available	No
Lumen	1600 Lm
MacAdam	SDCM 4
Beam	24°
CCT	3000K
CRI	≥82
UGR	-
LED Life	50.000 h
Insulation class	Class II
IP	20
Material	Aluminum
Warranty	5 years
Net Weight	0,610 Kg
Volume	0,0046 m³

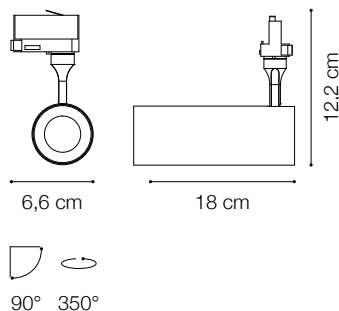

Code 189536
Item name SMILE HONEYCOMB PER TRACKLIGHTS 15W



Code 189543
Item name SMILE DIFFUSORE ELLITTICO PER TRACKLIGHTS 15W



Code 189505
Item name SMILE ANELLO FRONTALE BIANCO PER TRACKLIGHTS 15W



Code 170145
Item name LINK SINGLE CONNECTION WH ON-OFF

